

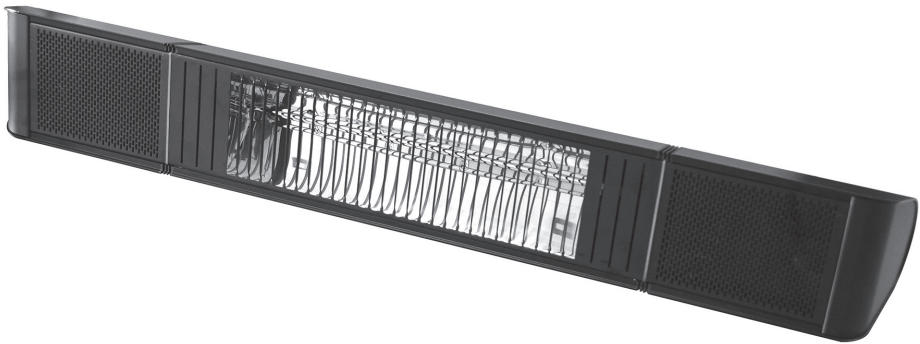

HELLION ELECTRIC HEATER WITH SPEAKERS

Model No. GM135-042



- 2000W heating power with 6 heat settings
- Wireless music streaming
- Two 5W and two 1W treble Bluetooth speakers
- Tungsten filament heating element with low glare reflector
- Rust resistant anodised aluminium construction
- Bluetooth-enabled with purpose-built app to control heat and music settings
- Remote control included
- Adjustable wall bracket included
- 1.5m power cord
- Designed for outdoor use
- IP65 dust tight and water resistant
- Rating: 220-240V~, 50Hz
- Approved to NZ standards
- Dimensions (mm): 950 W x 140 D x 180 H

Important: Retain these instructions for future use.

Gasmate® is a registered trademark of: Sitro Group Australia Pty Ltd www.gasmate.com.au
Aber Living - Hamilton, N.Z. www.gasmate.co.nz

INSTALLATION, OPERATION AND MAINTENANCE INSTRUCTIONS

BEFORE FIRST USE

- Read and follow all the instructions below even if you feel you are familiar with the heater.
- Remove the packing and make sure that the heater is intact. If in doubt do not use the heater and contact the place of purchase.
- Do not leave packaging materials such as bags and staples within reach of children.
- Dispose of packaging carefully and with consideration for the environment.
- It is ideal to retain the heater carton for seasonal storage.

For your convenience record the date you received the heater on the warranty page of these instructions, and attach your proof of purchase. Retain this information in the event that a warranty service is required.

NOTE: The rating of this heater (as marked on the rating label) is based on specific loading tests. Normal use or the use of other recommended attachments may draw significantly less power.

IMPORTANT SAFETY INFORMATION

Before attempting to operate this heater, the following basic safety precautions should be taken to reduce the risk of fire, electric shock and personal injury. It is important to read the instruction manual and to understand its' applications, limitations and potential hazards associated with this heater.



WARNING: DO NOT COVER IN ORDER TO AVOID OVERHEATING.

To reduce the risk of fire, electrical shock or injury to persons or property:

- To avoid overheating, keep airflow grilles clear of dust and hair build up - especially if you have pets.
- Use only the voltage specified on the rating label of the heater.
- Do not cover or restrict airflow to the inlet or outlet grilles in any manner as the heater may overheat and become a fire risk.
- Do not cover grilles, block entry or exits of airflow by placing the heater against any surface. Keep all objects at least 1 metre from the front, side and rear of the heater.

- Do not locate in areas of high foot traffic, ensure the power cord and heater are in view to avoid accidents.
- Do not operate in areas where gasoline, paint or other flammable liquids are used or stored.
- This heater heats up when in use. To avoid burns, do not touch the front of the heater or any of the grilles or vents.
- Before moving the heater, switch off the heater by unplugging it from the wall and allowing it to cool.
- Do not use the heater to dry clothes.
- Do not insert or allow foreign objects or metal utensils into any ventilation or exhaust openings as this may cause an electric shock, fire or damage to the heater.
- Do not use this heater in the immediate surroundings of a bath, a shower or a swimming pool.
- Do not immerse in liquid or use the heater within 1m or above a water source as this could create an electrical shock hazard.
- If the heater accidentally comes into contact with water switch off the power supply and do not touch the heater.
- Do not operate any heater with a damaged cord or plug or after the heater malfunctions or has been dropped or damaged in any manner – in order to avoid a hazard. Return to a qualified electrical person for service or repair.
- Do not operate the heater with wet hands.
- Do not connect the heater to the mains voltage until completely assembled and adjusted.
- Always operate level, on a flat surface only.
- Unroll the cord before operating. Operating with a coiled cord may cause overheating and fire risk.
- This heater is NOT designed to run off an extension cord. If you require an additional power point please have one installed by a qualified electrician.
- Do not remove the plug from the power socket until the heater has been switched off.
- The use of extension cords may cause power voltage loss which will result in damage to the heater this will NOT be covered under warranty.
- Always hold the plug when removing it from the wall, do not pull the cord.
- Always unplug the heater when it is not in use.
- Do not allow the cord to come in contact with the heater surface during operation.

- This heater is not intended for use by persons (including children) with reduced physical, sensory or mental capabilities, or lack of experience and knowledge, unless they have been given supervision or instruction concerning use of the heater by a person responsible for their safety.
- Children should be supervised to ensure that they do not play with the heater.
- This heater is intended for light domestic use and not for heavy duty commercial or industrial use.
- The heater must not be located immediately below or in front of a socket-outlet.
- CAUTION: In order to avoid a hazard due to inadvertent resetting of the thermal cut-out, this heater must not be supplied through an external switching device, such as a timer, or connected to a circuit that is regularly switched on and off by the utility.
- Never remove the cover of the heater – in case of a fault contact a qualified service person.
- Repairs should only be carried out by qualified persons using original spare parts. Failure to do so may result in considerable danger to the operator.
- Use this heater only as described in this manual.
- Any other use is not recommended by the manufacturer and may cause fire, electric shock or injury.
- The remote control function is line of sight and may not operate if something or someone is in the way of the signal.



FOR YOUR SAFETY

WARNING: Fire risk exists if this heater is covered or positioned close to combustible materials.

Always ensure you select the correct fixing accessories which suit the particular material you are attaching to, if in doubt please discuss with your local retailer or local hardware store. This heater is not designed for use within 1m or above a water source. All installations must meet the requirements of Australia Standard AS/NZS 3000:2007.

NOTE: When using this heater outside ensure that it is connected directly to an outdoor power point.

The electrical system of this heater must be connected with an automatic 30mA circuit breaker and/or residual current device (RCD). If uncertain have a qualified electrician check your electrical system before installation and/or use.

All electrical connections are made in a dry area.

Outdoor power points must be weatherproof and installed by a qualified electrician.

The distributor is not responsible for incorrectly chosen additional fixing accessories or any damage which may be caused by an incorrectly fitted heater.

ELECTRICAL DATA

IMPORTANT

This product is fitted with a sealed electrical connection plug that is compatible with the heater, the mains supply for New Zealand and meets the requirements of international standards. This heater must be connected to a supply voltage that is equal to that stated on the rating label.

If the mains connection plug or power cord becomes damaged it must be replaced with a complete assembly that is identical to the original, and this must be replaced by an authorised service centre.

Always follow the New Zealand requirements for connection to the mains supply. If in doubt always consult a qualified electrician.

Technical Specification

Model	GM135-042
Voltage:	220V-240V~ 50Hz
Input Wattage:	2000W
Unit Weight:	5kg
IP Rating:	IP65

Heater specifications can be found on the data label.

Installation

This heater is not designed for use within 1m or above a water source.

Ensure that the heater is not positioned directly above, below or in front of a power point or switch.

This heater is not designed to be used with 3rd party timer or programmable system.

This electric heater complies with New Zealand and International standards and safety requirements. All installations must meet the requirements of New Zealand Standard AS/NZS 3000:2007.

SPECIFIC SAFETY INSTRUCTIONS



WARNINGS

Do not use the heater in areas where there is a risk of explosion or fire from flammable gases. Ensure that the heating area is kept clear of combustible materials. Do not use the heater in damp areas, without suitable ventilation. This heater is not designed for use within 1m or above a water source. Do not place within one metre (1m) of any water source. Do not place directly in front of, below or above any power points or switches. Fire risk exists if this heater is covered by or positioned near combustible materials.

- This heater is intended for domestic/ household use only.
- This heater is designed for outdoor use.
- Always ensure that this heater is installed as per the requirements noted in New Zealand Standard AS/ NZS 3000:2007.
- Always keep heater at least one metre (1m) from combustible materials.
- DO NOT locate this heater directly below, above or in front of the power supply socket or switch.
- DO NOT use this heater in either a bathroom or ensuite.
- DO NOT use a 3rd party timer, or programmable system with this heater.
- DO NOT clean the heater while the heater is on or plugged into the mains power supply.
- DO NOT touch any part of the heater while on, hot surfaces may burn.
- DO NOT use the heater as a dryer.
- DO NOT attempt to modify the heater, power cord, power plug or the supplied accessories in any way.
- DO NOT expose the heater to rain, water, or use in damp wet conditions.
- NEVER cover this heater.
- NEVER carry the heater by its power supply cord.
- NEVER use with the power cord coiled, bundled up or tied up. Always extend fully before use.
- Always ensure that the power cord is fully extended and NOT in contact with any part of the heater.
- NEVER use the heater if any part of it is damaged.
- Ensure that the heater is disconnected from the mains supply when installing, cleaning or removing/ installing.
- Ensure this heater is not left on when unattended.
- Ensure the heater is not used in areas where flammable gases are present, e.g. paint, petrol etc.
- Always allow the heater to cool, about one (1) hour after the heater has been turned off, before cleaning the heater.
- Always ensure that the heater is kept clean and free from dust.
- Only use this heater on a level surface.
- Always turn the heater OFF at the unit switch and the power point switch when not in use for extended periods of time.

BLUETOOTH OPERATION

A free, simple to use Bluetooth App is available to download for this heater for either your iPhone, iPad or Android device. The 'Gasmate Heater' app will allow you to connect remotely to other Gasmate smart heaters and control them independently. Control functions include:

- On/Off
- 6 step variable heat output from 25% to 100%
- Timer with auto shut off
- Password connection to heaters
- Individual heater identification and control
- Volume control (on heaters with Bluetooth speakers)
- Light control (on heaters with lights)

To download, search for 'Gasmate' in your app store and add to your device.

BLUETOOTH SPEAKERS CONNECTING STEPS

1. In standby position, short press the remote control button, turn on the power of the Bluetooth speakers, then long press this button in order to enter into Bluetooth pairing mode.
2. Open the Bluetooth function in your iPhone, iPad or Android device, find the "BT (Bluetooth) heater" in the device lists, then connect (pair).
3. When connecting is successful there will be a prompt tone, then you can play music from your iPhone, iPad or Android device.
4. Press the button again, it will turn off the Bluetooth speaker. The next time you open the app you will be automatically connected to your paired heater/s.

Note: Password is blank but you can create your own in the app.

You may have to adjust the volume in your Media Player app if sound is too low.

RESET OPERATION

- Press the Reset button, the power will be adjusted accordingly (Low, Middle, High, ON/OFF)
- Press the Reset button for at least 4 seconds, the heater will restore to factory settings

ASSEMBLY INSTRUCTIONS

For best results and your safety, please follow the instructions carefully. DO NOT modify this product in any way as the distributor will accept no liability for improper use.

Remove all package material (including anti-vibration object on the lamp) and check the heater, supply cord and plug for signs of damage.

Pay attention to the mounting place and all mounting material (dowels, screws). See figure 1. Ensure they are suitable and stable enough for mounting and holding the heater securely.

Before mounting, the minimum safe mounting distances and tilt angles shown in the figures below must be strictly followed.

- The distance between the bottom edge of the heater and the floor must be at least 1.8m. See figure 2.
- There must be a distance of at least 0.25m between the heater and the ceiling, roof or other overhangs. See figure 2.

Figure 1: Mounting bracket and anchor dowels provided. Connection from the wall to the infrared heater.

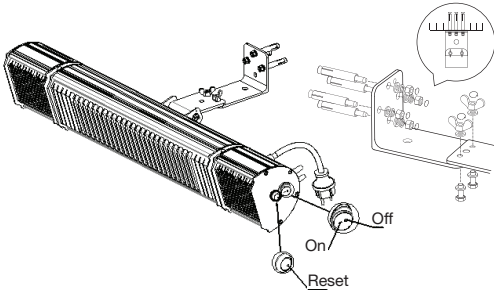
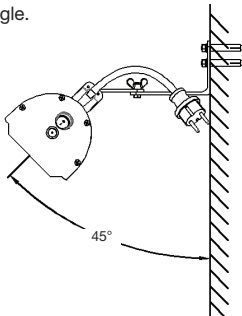

Figure 3: Tilt angle.



- There must be a distance of at least 0.5m on each side of the heater and walls or the like. See figure 2.
- Recommended degree of tilt of the heater to the mounting surface is 45°. See figure 3.

Pay attention that the heater is not installed in excessively windy locations.

Fix the mounting bracket to the wall first.

1. Take the wall bracket and select the position on the wall
2. Mark the holes for the wall bracket and drill
3. Using 4 suitable screws (not supplied) attach the wall bracket to the wall. Now assemble the wall bracket to the heater.

Ensure that the place it is to be installed is secure and firm. Or connect the appliance to a stand (optional).

Adjust the desired angle of heater and tighten all screws. Check the screws are secure. Mechanical bearing pressure and oscillation due to wind or rain could lead to loosening.

Plug in to the power point and use the remote control to turn on and test as shown on next page. Then observe for the first 10-15 minutes that the heater works trouble-free.



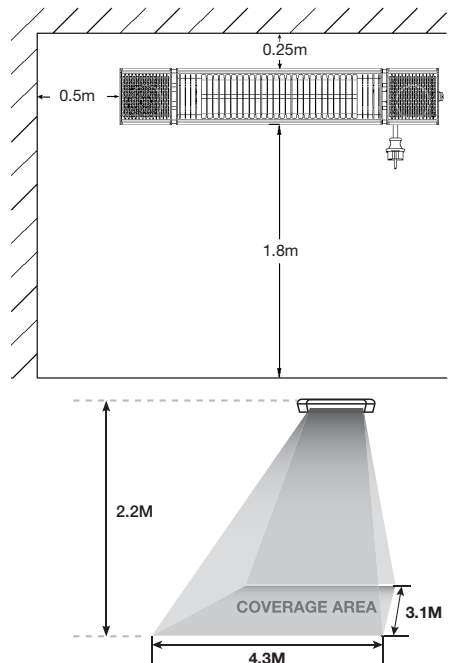

If you do not use for an extended period, please remove batteries from the remote.

Figure 2: Minimum distance to floor, ceiling and wall.

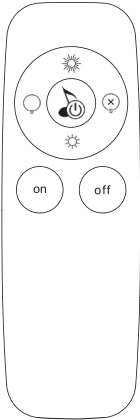

REMOTE CONTROL INSTRUCTIONS



Button	Graphic	Feature
Up icon		Up one heating level
Speaker/Bluetooth		Short press, turn on/off the speaker Long press, enter into Bluetooth pairing mode
Down icon		Down one heating level
On		To switch the heater on: Press ON. The patio heater has a soft start function of 33% power. 4 seconds after the heater has been turned on, it will automatically switch to the last heating level used. Note: On first-time use, after 4 seconds the heater will automatically switch to 100% power.
Off		To switch the heater off: Press OFF. The heater will switch to standby mode (the receiver indicator will light up).

Note: Light (left/right) buttons have no function on this model.

Remote maximum receiving distance: 6m line of sight

OPERATING INSTRUCTIONS

POSITIONING THE HEATER

The heater should only be operated at the minimum distances noted in Figure 2 on page 5.



IMPORTANT

- Heater must not be located immediately below a socket outlet.
- Heater must not be located in front of a socket outlet.

TO OPERATE

1. Plug into 240V AC power point.
2. To turn on - switch on the power point and the power switch on the rear of the heater.
3. See remote control instructions on previous page.
4. See Bluetooth instructions on page 4.
5. Unplug lead from power point when not in use.

IMPORTANT: Turn off the heater. Switch off the power switch and disconnect the heater from the power socket. Wait for the heater to be completely cool before cleaning (at least one hour).

CLEANING AND CARE

Always ensure that the heater has been left for one (1) hour to cool before cleaning.

- Turn off and disconnect from mains power, allow to cool.
- Wipe unit over with a damp, clean, soft lint-free cloth.
- For stubborn marks you can use a mild dish washing solution on a damp, clean, soft lint-free cloth.

NEVER use solvents, e.g. Petrol, Toluene, Methylated Spirits etc to clean the heater, as these will damage the surface finish and may cause a fire when unit is next used.

- **DO NOT** spray with liquids or submerge in liquids or water.
- **DO NOT** allow water or mild dish washing solution to enter or drip onto the heater.
- **DO NOT** attempt to clean the interior of the heater.
- **DO NOT** attempt to open the heater casing at any time.

ELECTRIC HEATER RANGE

Aber Living warrants the purchaser of this product against defects in workmanship and material, for a period of up to 12 months from the date of purchase. The warranty is non-transferable and becomes void if used for commercial or rental purposes.

Warranty and purchase receipt of this product are to be retained as proof of purchase and must be presented if making a claim under the terms of the Aber Living Warranty. Repairs under warranty are free of charge, provided the product is delivered to our Service Department or Authorised Service Agent and freight charges both ways are paid by the owner. No liability will be accepted for any loss of damage in transit.

Aber Living reserves the rights to replace or repair the product within the warranty period. Warranty does not apply to any defect, deterioration (including corrosion if located within 1km of the sea), loss, injury or damage occasioned by or as a result of the misuse or abuse, negligent handling or if the product has not been installed and used in accordance with the instructions. The warranty is void if there is evidence of the product being tampered with by unauthorised persons.

If the product includes one or a number of accessories, only the defective accessory or part will be replaced, eg. power cable, lamp, reflector.

In the event of Aber Living choosing to replace the product, the warranty will expire at the original date, i.e. 12 months from the original purchase date.

Where this product contains information from an overseas country, nothing in that information is intended to limit any condition, guarantee, right or remedy which may be available under the Consumer Guarantees Act 1993, except to the extent permitted by that Act.

Approved for Outdoor Use Only

For service, spare parts or product information in New Zealand, please call Aber Living on the Customer Service Line - 0800 161 161. www.aberliving.co.nz

YOUR PURCHASE RECORD (please complete)

Date of Purchase ____ / ____ / ____

Model Number _____

Serial Number (if applicable) _____

Purchased from _____

Attach copy of purchase receipt here